



Wendeschneidplatten-Werkzeuge

zum Bohren, Aufbohren und zur Fertigbearbeitung

Indexable insert drilling-, boring-
and finish machining tools

Unicut UNW

Unicut-Eco UNWE

Preci-Cut RPC

Verstellsysteme /
Adjusting systems

RPC / RPC-G / RPK

Flexispeed FLX



Powerbore KSB / KBH

Wendeschneidplatten /
Indexable inserts

H. BILZ

BOHREN SENKEN AUFBOHREN REIBEN

BORE COUNTERSINK COUNTERBORE REAM

	Aufbohr- und Zirkularfräswerkzeug / Boring and circular milling tool Unicut UNW D=14-40	3-5
	Schraubenkopfsenker / Screw head boring tool Unicut-Eco UNWE D=10-58	6-7
	Fertigbearbeitungswerkzeug / Finish machining tool Preci-Cut RPC D=18-40	8-9
	Verstellsysteme / Adjusting systems RPC / RPC-G / RPK D=16-250	10-11
	Flexispeed FLX D=18-39	12-15
	Powerbore KSB / KBH D=39-160	16-19
	Wendeschneidplatten Übersicht / Indexable inserts overview	20-21
	PKD-WSP-Schneidstoffsorten / PCD-Inserts-cutting material grades	22
	Formeln, Leistungsberechnung / Formulas, Power calculation	23
	Technischer Fragebogen / Technical questionnaire	24

Der Katalog enthält nur eine Auswahl lieferbarer Artikel. Auch viele nicht enthaltene Artikel sind teilweise ab Lager oder kurzfristig lieferbar. Bitte fragen Sie die Verfügbarkeit im Einzelfall bei uns an. Sortimentsänderungen durch Weiterentwicklung sowie Druckfehler und Irrtümer vorbehalten. / The catalog shows only a part of our range of products. Many other items are available on stock or within a short delivery time too. Please call and ask for availability. The product line is subject to change without notice. Errors excepted.

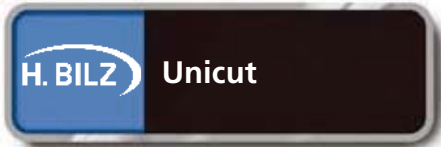

UNW03

Aufbohren und Zirkularfräsen

Boring and circular milling

D=14-17



D=18-40



UNW03



UNW03



3xD

IT9-11

GJL / GJS

ALU

ST(AHL)

NE

Vorteile:



- Für Planenkungen und tiefe Einsenkungen, z. B. für Schraubenkopfauflagen
- Hohe Zerspanungsleistung durch 3 Schneiden ab d=18
- Enge Bohrungstoleranzen (IT9-11)
- Einsetzbar auf steifen Maschinen ohne Führungszapfen

Advantages:

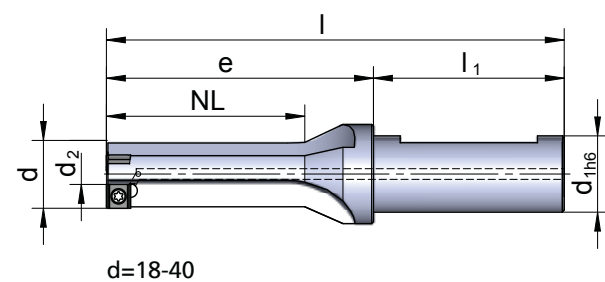
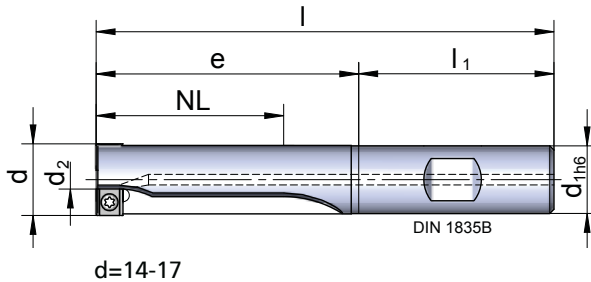
- For spotfacing and boring
- High stock removal rates
- Tight bore tolerances (IT9-11)
- Usable on rigid machines without pilot



Unicut UNW03 (NL = 2-3xd)

d _{+/-0,05*}	d ₁	d _{2*}	e	l	l ₁	NL	Best.-Nr./ Ord.-No		 **	 **
14	16	1,5	42	90	48	28	UNW03 1400	TX 25050	TX 208	06
15	16	2,5	42	90	48	30	UNW03 1500	TX 25050	TX 208	06
16	16	3,5	44	92	48	32	UNW03 1600	TX 25050	TX 208	06
17	16	4,5	44	92	48	34	UNW03 1700	TX 25050	TX 208	06
18	20	5,5	65	115	50	52	UNW03 1800	TX 25050	TX 208	06
19	20	6,5	65	115	50	53	UNW03 1900	TX 25050	TX 208	06
20	20	7,5	65	115	50	54	UNW03 2000	TX 25050	TX 208	06
21	20	8,5	65	115	50	54	UNW03 2100	TX 25050	TX 208	06
22	20	9,5	70	120	50	61	UNW03 2200	TX 25050	TX 208	06
23	20	10,5	70	120	50	61	UNW03 2300	TX 25050	TX 208	06
24	20	11,5	70	120	50	61	UNW03 2400	TX 25050	TX 208	06
25	20	12,5	70	120	50	61	UNW03 2500	TX 25050	TX 208	06
26	25	13,5	94	150	56	78	UNW03 2600	TX 25050	TX 208	06
27	25	14,5	94	150	56	78	UNW03 2700	TX 25050	TX 208	06
28	25	9,2	94	150	56	84	UNW03 2800	TX 35075	TX 215	09
29	25	10,2	104	160	56	87	UNW03 2900	TX 35075	TX 215	09
30	25	11,2	104	160	56	90	UNW03 3000	TX 35075	TX 215	09
31	25	12,2	104	160	56	93	UNW03 3100	TX 35075	TX 215	09
32	32	13,2	115	175	60	96	UNW03 3200	TX 35075	TX 215	09
33	32	14,2	115	175	60	99	UNW03 3300	TX 35075	TX 215	09
34	32	15,2	115	175	60	102	UNW03 3400	TX 35075	TX 215	09
35	32	16,2	115	175	60	105	UNW03 3500	TX 35075	TX 215	09
36	32	17,2	125	185	60	108	UNW03 3600	TX 35075	TX 215	09
37	32	18,2	125	185	60	111	UNW03 3700	TX 35075	TX 215	09
38	32	19,2	125	185	60	114	UNW03 3800	TX 35075	TX 215	09
39	32	20,2	130	190	60	117	UNW03 3900	TX 35075	TX 215	09
40	32	15	130	190	60	120	UNW03 4000	TX 45115	TX 215	12

* Maße und Toleranzen nur in Verbindung mit SCH...
FRH- und ...FRZ-Wendeschneidplatten /
Dimensions and tolerances for SCHX...FRH- and
...FRZ-inserts only

Andere Abmessungen und Ausführungen auf Anfrage /
Other dimensions and designs upon request

** separat bestellen / order separately

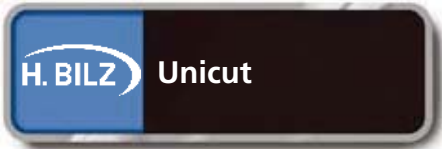

UNW

D=14-17 D=18-32 UNW
1xD IT9-11
GJL / GJS ALU ST(AHL) NE

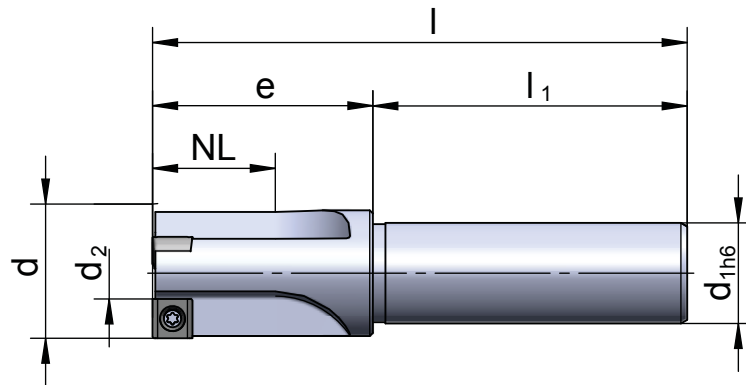

Unicut UNW (NL < 1xD)

d _{+/-0,05*}	d ₁	d _{2*}	e	l	l ₁	NL	Best.-Nr./ Ord.-No			
							UNW03			
14	12	1,5	30	75	45	15	UNW 140012	TX 25050	TX 208	06
15	12	2,5	30	75	45	15	UNW 150012	TX 25050	TX 208	06
16	12	3,5	30	75	45	15	UNW 160012	TX 25050	TX 208	06
17	16	4,5	35	85	50	19	UNW 170016	TX 25050	TX 208	06
18	16	5,5	35	85	50	19	UNW 180016	TX 25050	TX 208	06
19	16	6,5	35	85	50	19	UNW 190016	TX 25050	TX 208	06
20	16	7,5	35	85	50	19	UNW 200016	TX 25050	TX 208	06
21	16	8,5	35	85	50	19	UNW 210016	TX 25050	TX 208	06
22	16	9,5	35	85	50	19	UNW 220016	TX 25050	TX 208	06
23	16	10,5	35	85	50	19	UNW 230016	TX 25050	TX 208	06
24	16	11,5	35	85	50	19	UNW 240016	TX 25050	TX 208	06
25	16	12,5	35	85	50	19	UNW 250016	TX 25050	TX 208	06
26	20	13,5	40	100	60	23	UNW 260020	TX 25050	TX 208	06
27	20	14,5	40	100	60	23	UNW 270020	TX 25050	TX 208	06
28	20	9,2	40	100	60	22	UNW 280020	TX 35075	TX 215	09
29	20	10,2	40	100	60	22	UNW 290020	TX 35075	TX 215	09
30	20	11,2	40	100	60	22	UNW 300020	TX 35075	TX 215	09
31	20	12,2	40	100	60	21	UNW 310020	TX 35075	TX 215	09
32	20	13,2	40	100	60	21	UNW 320020	TX 35075	TX 215	09

Weitere Schaftvarianten / Other shanks:

(Bei Bestellung bitte angeben / Please indicate with order)

Whistle Notch = DIN 1835 E



Weldon = DIN 1835 B



* Maße und Toleranzen nur in Verbindung mit SCH...FRH- und ...FRZ-Wendeschneidplatten / Dimensions and tolerances for SCHX...FRH- and ...FRZ-inserts only

** separat bestellen / order separately

Andere Abmessungen und Ausführungen auf Anfrage / Other dimensions and designs upon request

Schnittdatenempfehlung / Cutting data recommendation:

		Stahl Steel	Nichtrostender Stahl Stainless steel	Gusseisen Cast iron	Aluminium
		z.B. / e.g. C45E	z.B. / e.g. X20Cr13	z.B. / e.g. GJL, GJS	z.B. / e.g. AlSi10Mg
HM / Carbide	Vc	60 - 150	40 - 90	60 - 160	100 - 500
Cermet (C1)	Vc	80 - 200			100 - 500
PKD / PCD (D1)	Vc				100 - 500
HSSE (S6)	Vc	25 - 50	15 - 35		
Ø d					
14 - 27	f	0,12 - 0,3	0,1 - 0,2	0,15 - 0,3	0,2 - 0,35
28 - 40	f	0,2 - 0,4	0,15 - 0,25	0,25 - 0,5	0,25 - 0,5

Schnittgeschwindigkeit / Cutting speed
Vc (m/min)

Vorschub / Infeed
f (mm/U) / (mm/rev)

Ausreichende Kühlschmierstoff-Zufuhr erforderlich / Sufficient coolant supply needed

Merkmale / Specifications		Best.-Nr. / Ord.-No	Werkstoffgruppe (s. S. 22) / Material class (s. p. 22)													
			N	K	S	P	N	K	MKH	P	P M	P M H	P M K S			
			Schneidstoffsorte (s. S. 22) / Grade (s. p. 22)													
Aufbohr-Wendeschneidplatten für UNW und UNW03 / Boring inserts for UNW and UNW03																
Schnittbreite / Cutting width < 0,5		09	SCHW 0903AC FRH...										K9			
Schnittbreite < 0,5; Führungsfasen* / Cutting width < 0,5; Guiding chamfers*		06	SCHW 0602AC FRZ...										K9			
		09	SCHW 0903AC FRZ...										K9			
		12	SCHW 1204AC FRZ...										K9			
PKD; Schnittbreite < 2,5 bzw. 3,5 / PCD; Cutting width < 2,5 resp. 3,5		06	SCHW 060202 FRH...									D1				
		09	SCHW 090302 FRH...									D1				
		09	SCHW 090304 FRH...										D1			
PKD; volle Schnittbreite / PCD; entire cutting width		06	SCHW 060202 FR5...									D1				
		09	SCHW 090302 FR5...									D1				
		12	SCHW 120402 FR5...										D1			
Geschliffene Spanleitstufen / Ground chip breakers		06	SCHX 060204 FRH...	AK1	C1				K1	K9	P2	P5	P9			
		09	SCHX 090304 FRH...	AK1	C1				K1	K9	P2	P5	P9	S6		
		12	SCHX 120404 FRH...	AK1	C1				K1	K9	P2	P5	P9	S6		
Führungsfasen*; geschliffene Spanleitstufen / Guiding chamfers*; ground chip breakers		06	SCHX 060202 FRZ...						K1	K9	P2	P5	P9			
		06	SCHX 060204 FRZ...	AK1	C1				K1	K9	P2	P5	P9	S6		
		09	SCHX 090304 FRZ...	AK1	C1				K1	K9	P2	P5	P9	S6		
		09	SCHX 090308 FRZ...						K1			P5		S6		
		12	SCHX 120404 FRZ...	AK1					K1	K9	P2	P5	P9	S6		
Führungsfasen*; Spanleitstufen** für kurze Späne / Guiding chamfers*; chip breakers** for short chips		06	SCHX 060204 FRZ7...										P9			
		09	SCHX 090304 FRZ7...											P9		
		12	SCHX 120404 FRZ7...											P9		
Planken- und Fräs-Wendeschneidplatten für UNW und UNW03 / Spotfacing and milling inserts for UNW and UNW03																
Ohne Spanleitstufen / Without chip breakers		06	SCHW 060204 FN...	K1									K9			
		09	SCHW 090304 FN...	K1										K9	P2	
4 geschliffene Spanleitstufen / 4 ground chip breakers		06	SCHX 060202 FN1...	K1									P2	P5		
		09	SCHX 090304 FN1...	K1										P2	P5	
4 gesinterte Spanleitstufen / 4 sintered chip breakers		06	SCMT 060204 EN...	K1									K9	P2	P5	
		09	SCMT 090304 EN...	K1										K9	P2	P5
		12	SCMT 120404 EN...	K1										K9		P5

Andere WSP-Varianten und Sorten auf Anfrage / Other indexable insert designs and grades upon request

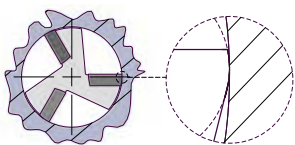

* Rund geschliffene Führungsfasen der WSP (...Z...) verhindern Rattern und glätten die Bohrungsoberfläche -> gut geeignet für schlanke Werkzeuge mit mindestens 3 Schneiden / Round ground guiding chamfers on the insert (...Z...) prevent chattering and burnish the bore surface -> well suitable for lean tools with min. 3 cutting edges

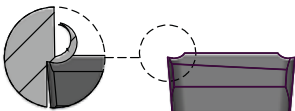

** Tiefe Schneidkanten und kurze Spanleitstufen (...7...) erzeugen kurze Späne schon bei geringen Spanungsdicken -> gut geeignet für lang spanende Werkstoffe / Low cutting edge and short chip breakers (...7...) generate short chips already at low feed rates -> well suitable for long chipping materials

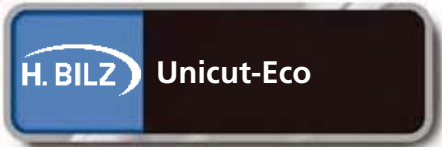

**Schraubenkopfsenker UNWE /
Screw head counterbore UNWE**

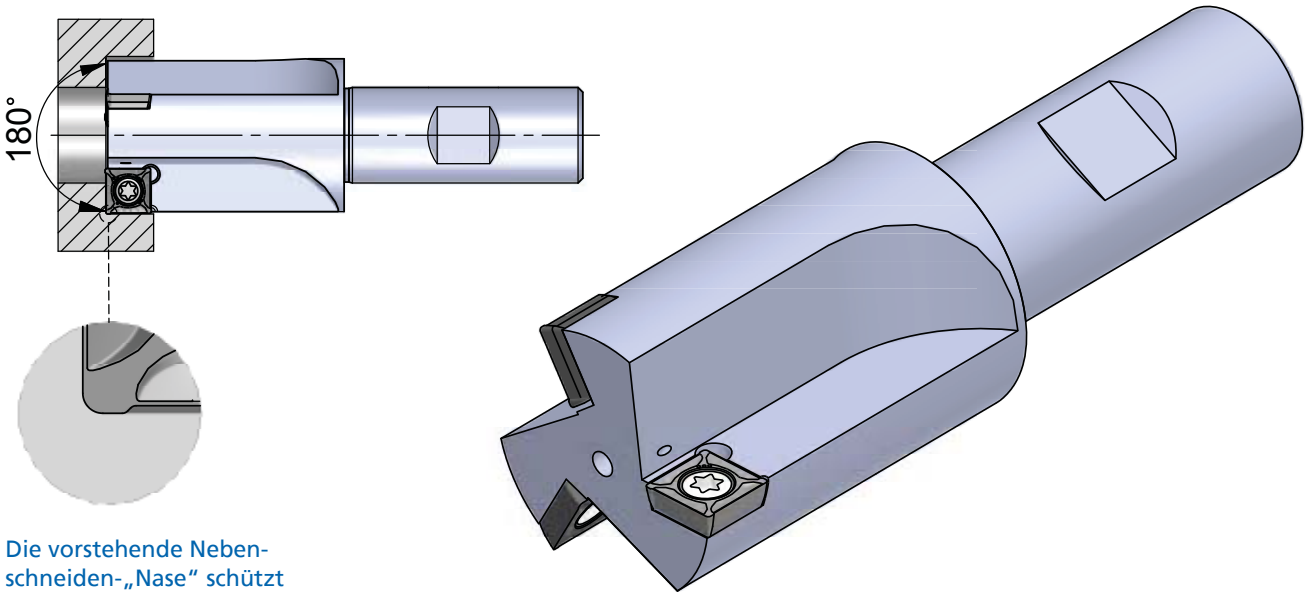
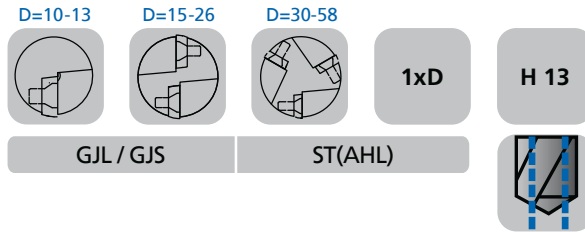

Die vorstehende Nebenschneiden-„Nase“ schützt die im Durchmesser zurückstehende Hauptschneide vor Verschleiß /
The „nose“ on the minor cutting edge protects the major cutting edge on the external tool diameter

Vorteile:

- Der 180°- Schraubenkopfsenker für M5 bis M36
- Preisgünstige Sinter-WSP SCM_X-Eco mit vier nutzbaren Schneiden
- Schneidstoffsorte U9 universell für Stahl und Gusseisen geeignet
- Einsetzbar auf steifen Maschinen ohne Führungzapfen

Advantages:

- The 180° Screw head counterbore for M5 to M36
- Low priced sinter-insert SCM_X-Eco with four usable cutting edges
- Insert grade U9 is well usable for steel and cast iron
- Applicable on rigid machine tools without pilot

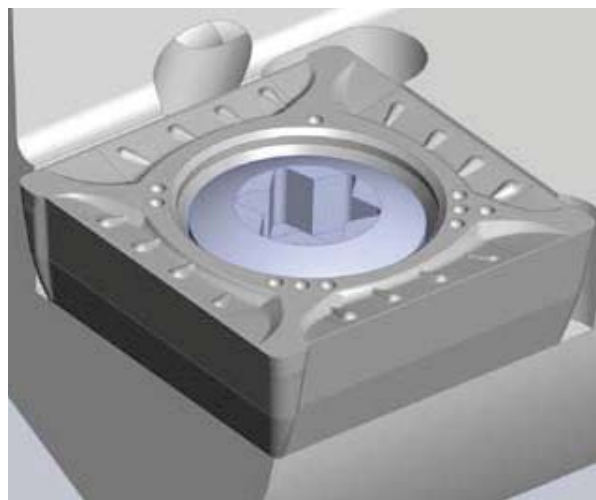

WSP / Insert: SCM_X-Eco

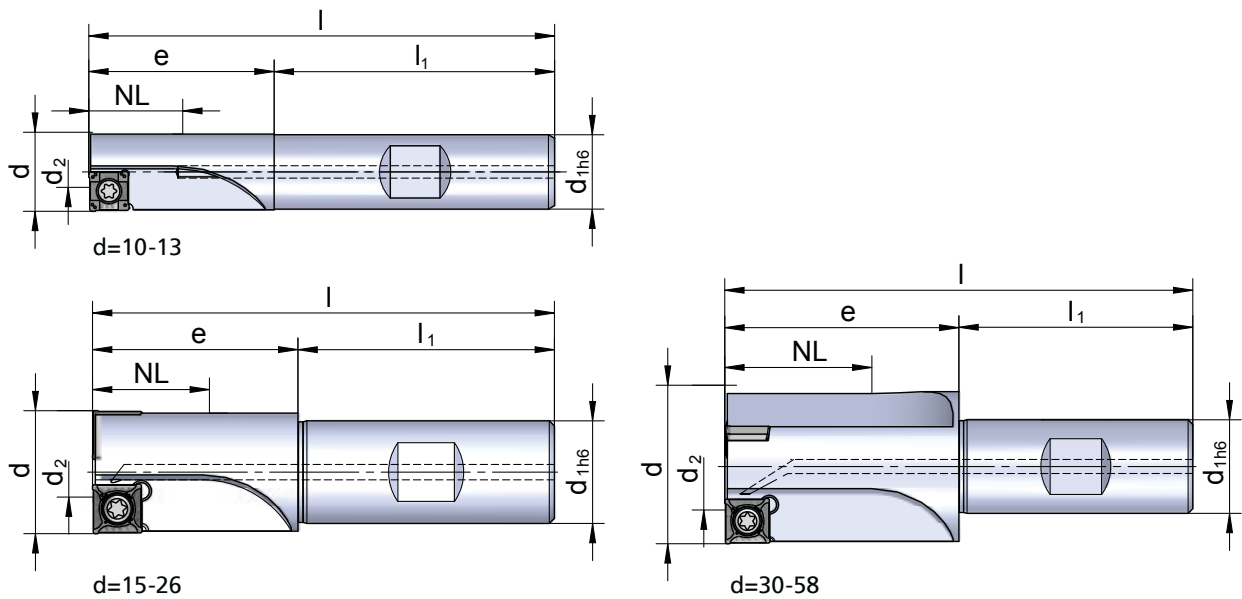

Unicut-Eco UNWE (NL < 1xd)

d _{+0,3}	d ₁	d ₂	e	l	l ₁	NL	Best.-Nr./ Ord.-No			
							UNWE			
10	12	4,5	30	75	45	6	UNWE 1000	TX 25045	TX 208	SCMX060204ERU9
11	12	4,5	30	75	45	7	UNWE 1100	TX 25045	TX 208	SCMX060204ERU9
13	12	4,5	30	75	45	7	UNWE 1300	TX 25050	TX 208	SCMX060204ERU9
15	12	5	30	75	45	13	UNWE 1500	TX 25050	TX 208	SCMX060204ERU9
16	12	6	30	75	45	13	UNWE 1600	TX 25050	TX 208	SCMX060204ERU9
18	16	8	32	80	48	15	UNWE 1800	TX 25050	TX 208	SCMX060204ERU9
20	16	10	37	85	48	20	UNWE 2000	TX 25050	TX 208	SCMX060204ERU9
24	20	8	40	90	50	21	UNWE 2400	TX 35075	TX 215	SCMX090304ERU9
26	20	10	40	90	50	21	UNWE 2600	TX 35075	TX 215	SCMX090304ERU9
30	20	14	50	100	50	31	UNWE 3000	TX 35075	TX 215	SCMX090304ERU9
33	20	17	50	100	50	31	UNWE 3300	TX 35075	TX 215	SCMX090304ERU9
36	25	20	54	110	56	31	UNWE 3600	TX 35075	TX 215	SCMX090304ERU9
40	32	24	55	115	60	36	UNWE 4000	TX 35075	TX 215	SCMX090304ERU9
46	32	30	60	120	60	41	UNWE 4600	TX 35075	TX 215	SCMX090304ERU9
50	32	28	70	130	60	50	UNWE 5000	TX 45115	TX 215	SCMX120404ERU9
54	40	32	70	140	70	50	UNWE 5400	TX 45115	TX 215	SCMX120404ERU9
58	40	36	70	140	70	50	UNWE 5800	TX 45115	TX 215	SCMX120404ERU9

** separat bestellen / order separately

Andere Abmessungen und Ausführungen auf Anfrage /
Other dimensions and designs upon request

Bestellbeispiel / Order example:

- 3 Stück/pieces UNWE 2400
- 10 Stück/pieces SCMX090304ERU9

Schnittdatenempfehlung / Cutting data recommendation:

	Vc	Stahl Steel	Gusseisen Cast iron
		z.B. / e.g. C45E	z.B. / e.g. GJL, GJS
		60 - 200	60 - 200
Ø d			
10 - 13	f	0,06 - 0,12	0,08 - 0,15
15 - 20	f	0,12 - 0,2	0,15 - 0,25
24 - 26	f	0,15 - 0,25	0,18 - 0,3
30 - 46	f	0,2 - 0,4	0,25 - 0,5
50 - 58	f	0,3 - 0,5	0,35 - 0,6

**Schnitt-
geschwindigkeit /
Cutting speed**

Vc (m/min)

Vorschub / Infeed

f (mm/U) /
(mm/rev)

Ausreichende Kühlschmierstoff-
Zufuhr erforderlich / Sufficient
coolant supply needed



RPC mit Exzenterstiftverstellung RPC with eccentric pin adjustment

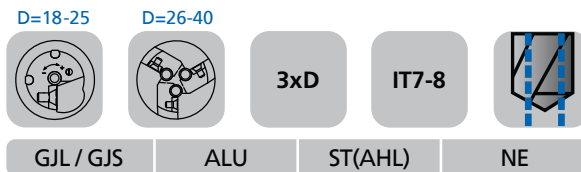

Vorteile:

- Hohe Zerspanungsleistung durch 3 Schneiden ab $d=26$
- Enge Bohrungstoleranzen (IT7-8)
- Schnell und präzise einstellbar (Zustellung $2\mu\text{m}/^\circ$)
- Schnittbreite bis ca. 4 mm
- Einsetzbar auf steifen Maschinen

Advantages:

- High stock removal rates with 3 cutting edges from $d=26$
- Tight bore tolerances (IT7-8)
- Quick and precise setting of cutting diameter (inclination $2\mu\text{m}/^\circ$)
- Cutting width up to 4 mm
- Usable on rigid machines

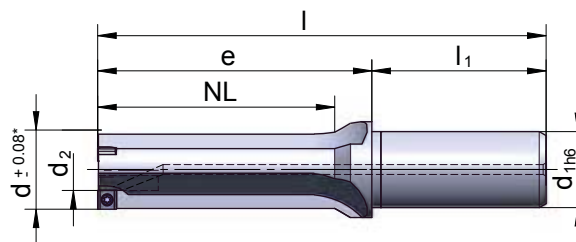
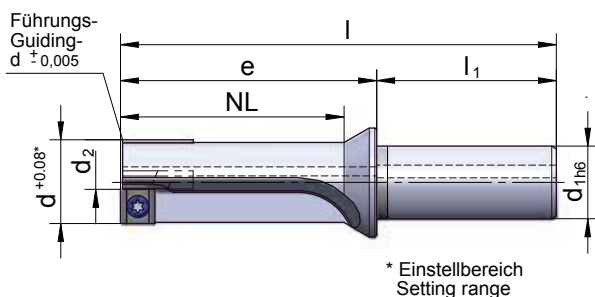

Preci-Cut RPC

d	d ₁	d ₂	e	l	l ₁	NL	Best.-Nr./ Ord.-No			
18	20	0,4	65	115	50	52	RPC03 1800	TX 35075	TX 215	09
19	20	0,2	65	115	50	53	RPC03 1900	TX 35075	TX 215	09
20	20	1,2	65	115	50	54	RPC03 2000	TX 35075	TX 215	09
21	20	2,2	65	115	50	54	RPC03 2100	TX 35075	TX 215	09
22	20	3,2	70	120	50	61	RPC03 2200	TX 35075	TX 215	09
23	20	4,2	70	120	50	61	RPC03 2300	TX 35075	TX 215	09
24	20	5,2	70	120	50	62	RPC03 2400	TX 35075	TX 215	09
25	20	6,2	70	120	50	62	RPC03 2500	TX 35075	TX 215	09
26	25	13,5	94	150	56	78	RPC03 2600	TX 25050	TX 208	06
27	25	14,5	94	150	56	81	RPC03 2700	TX 25050	TX 208	06
28	25	15,5	94	150	56	84	RPC03 2800	TX 25050	TX 208	06
29	25	16,5	104	160	56	87	RPC03 2900	TX 25050	TX 208	06
30	25	17,5	104	160	56	90	RPC03 3000	TX 25050	TX 208	06
31	25	18,5	104	160	56	93	RPC03 3100	TX 25050	TX 208	06
32	32	13,2	115	175	60	96	RPC03 3200	TX 35075	TX 215	09
33	32	14,2	115	175	60	99	RPC03 3300	TX 35075	TX 215	09
34	32	15,2	115	175	60	102	RPC03 3400	TX 35075	TX 215	09
35	32	16,2	115	175	60	105	RPC03 3500	TX 35075	TX 215	09
36	32	17,2	125	185	60	108	RPC03 3600	TX 35075	TX 215	09
37	32	18,2	125	185	60	111	RPC03 3700	TX 35075	TX 215	09
38	32	19,2	125	185	60	114	RPC03 3800	TX 35075	TX 215	09
39	32	20,2	130	190	60	117	RPC03 3900	TX 35075	TX 215	09
40	32	21,2	130	190	60	120	RPC03 4000	TX 35075	TX 215	09

** separat bestellen / order separately

Andere Abmessungen und Ausführungen auf Anfrage /
Other dimensions and designs upon request

Weitere Schaftvarianten / Other shanks:

(Bei Bestellung bitte angeben / Please indicate with order)

Whistle Notch = DIN 1835 E

Weldon = DIN 1835 B



Bestellbeispiel / Order example:

- 3 Stück/pieces RPC03 4000
- 10 Stück/pieces SCHX090304FRZK9

Merkmale / Specifications		Best.-Nr. / Ord.-No	Werkstoffgruppe (s. S. 22) / Material class (s. p. 22)															
			N	K	S	P	M	K	H	P	M	P	M	H	P	M	K	
			Schneidstoffsorte (s. S. 22) / Grade (s. p. 22)															
Wendeschneidplatten für RPC / Indexable inserts for RPC																		
Schnittbreite / Cutting width < 0,5		09	SCHW 0903AC FRH...***										K9					
Schnittbreite / Cutting width < 0,5 Führungsfasen* / Guiding chamfers*		06	SCHW 0602AC FRZ...***										K9					
		09	SCHW 0903AC FRZ...***											K9				
PKD; Schnittbreite < 2,5 bzw. 3,5 / PCD; Cutting width < 2,5 resp. 3,5		06	SCHW 060202 FRH...													D1		
		09	SCHW 090302 FRH...													D1		
		09	SCHW 090304 FRH...														D1	
PKD; volle Schnittbreite / PCD; entire cutting width		06	SCHW 060202 FR5...													D1		
		09	SCHW 090302 FR5...													D1		
geschliffene Spanleitstufen / ground chip breakers		06	SCHX 060204 FRH...	AK1	C1					K1	K9	P2	P5	P9				
		09	SCHX 090304 FRH...	AK1	C1					K1	K9	P2	P5	P9	S6			
Führungsfasen*; geschliffene Spanleitstufen / Guiding chamfers*; ground chip breakers		06	SCHX 060202 FRZ...							K1	K9	P2	P5	P9				
		06	SCHX 060204 FRZ...	AK1	C1					K1	K9	P2	P5	P9	S6			
		09	SCHX 090304 FRZ...	AK1	C1					K1	K9	P2	P5	P9	S6			
Führungsfasen*; Spanleitstufen** für kurze Späne / Guiding chamfers*; chip breakers** for short chips		06	SCHX 060204 FRZ7...														P9	
		09	SCHX 090304 FRZ7...															P9

*** Anpassung der Werkzeugführung (d<26) an die WSP-Eckengeometrie erforderlich / Modification of tool guide pads (d<26) according insert geometry necessary

Andere WSP-Varianten und Sorten auf Anfrage / Other indexable insert designs and grades upon request

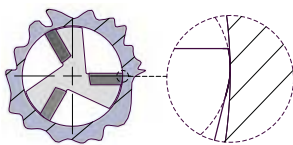

* Rund geschliffene Führungsfasen der WSP (...Z...) verhindern Rattern und glätten die Bohrungs Oberfläche -> gut geeignet für schlanke Werkzeuge mit mindestens 3 Schneiden / Round ground guiding chamfers on the insert (...Z...) prevent chattering and burnish the bore surface -> well suitable for lean tools with min. 3 cutting edges

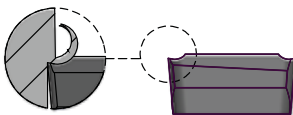

** Tiefe Schneidkanten und kurze Spanleitstufen (...Z...) erzeugen kurze Späne schon bei geringen Spanungsdicken -> gut geeignet für lang spanende Werkstoffe / Low cutting edge and short chip breakers (...Z...) generate short chips already at low feed rates -> well suitable for long chipping materials

Schnittdatenempfehlung / Cutting data recommendation:

		Stahl Steel	Nichtrostender Stahl Stainless steel	Gusseisen Cast iron	Aluminium
		z.B./e.g. C45E	z.B./e.g. X20Cr13	z.B./e.g. GJL, GJS	z.B./e.g. AlSi10Mg
HM / Carbide	Vc	60 - 150	40 - 90	60 - 160	100 - 500
Cermet (C1)	Vc	80 - 200			180 - 600
PKD / PCD (D1)	Vc				180 - 600
Ø d					
18 - 25	f	0,06 - 0,15	0,06 - 0,15	0,08 - 0,15	0,1 - 0,2
26 - 40	f	0,15 - 0,4	0,12 - 0,3	0,15 - 0,5	0,2 - 0,5

Schnittgeschwindigkeit / Cutting speed

Vc (m/min)

Vorschub / Infeed

f (mm/U) / (mm/rev)

Ausreichende Kühlschmierstoff-Zufuhr erforderlich / Sufficient coolant supply needed



Verstellungssysteme
(für individuelle Werkzeuglösungen)
Adjustment systems
(for individual tool solutions)

IT 7-8

GJL / GJS ALU ST(AHL) NE

Schiebekeilverstellung / Wedge adjustment

RPC

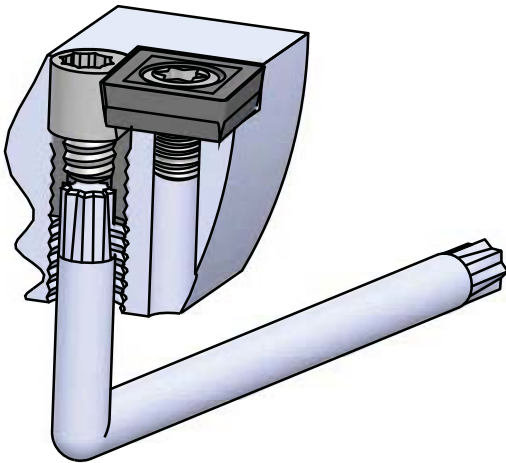

RPC-G

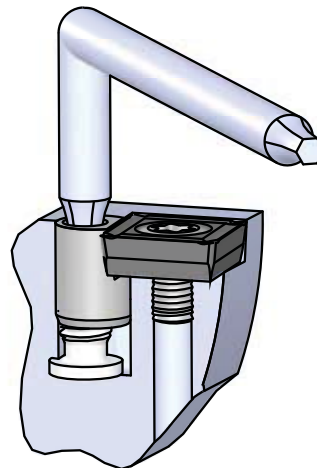

Vorteile:

- Aufbohren und Reiben in einem Arbeitsgang
- Eng gestufte Werkzeuge realisierbar
- Enge Bohrungstoleranzen (IT7-8; mit modifizierten Verstell-elementen auch IT6)
- Einstellbereich bis 0,15 mm im Durchmesser
- Schnell und präzise einstellbar (Zustellung 2µm/°)
- Große Schnittbreiten durch großflächige Anlage der WSP am Schiebekeil möglich
- Für viele WSP-Formen (A, C, L, M, S, X...) und Größen verwendbar
- Zwei Baureihen:
 - **RPC:** rückseitig einstellbar; ab D=30
 - **RPC-G:** WSP-seitig einstellbar; ab D=16
- Zweirichtungsverstellung möglich durch Kombination mit Exzenterstiftverstellung (z. B. für preisgünstige Sinter-WSP)

Advantages:

- Boring and finishing in one pass
- Short stepped tools can be realized
- Tight bore tolerances (IT7-8; with modified wedge also IT6)
- Diameter setting range 0.15 mm
- Quick and precise setting (inclination 2µm/°)
- High rigidity due to large area contact between insert and wedge
- Two lines:
 - **RPC:** adjustable from back side for D=30 and up
 - **RPC-G:** adjustable from insert side for D=16 and up
- Adjustment in two directions by combination with eccentric pin adjustment (e. g. for the use of low priced sinter-Inserts)

RPC: Kleinste verstellbare Durchmesser / RPC: Smallest cutting diameter for radial adjustment

WSP-Größe / Insert size	Z1	Z2	Z3
SC..0903..	30	31	46
SC..1204..	36	38	53

RPC-G: Kleinste verstellbare Durchmesser / RPC-G: Smallest cutting diameter for radial adjustment

WSP-Größe / Insert size	Z1	Z2	Z3
SC..0602..	16	22	29
SC..0903..	29	32	43
SC..1204..	36	43	59

Kassetensystem RPK / Cartridge system RPK

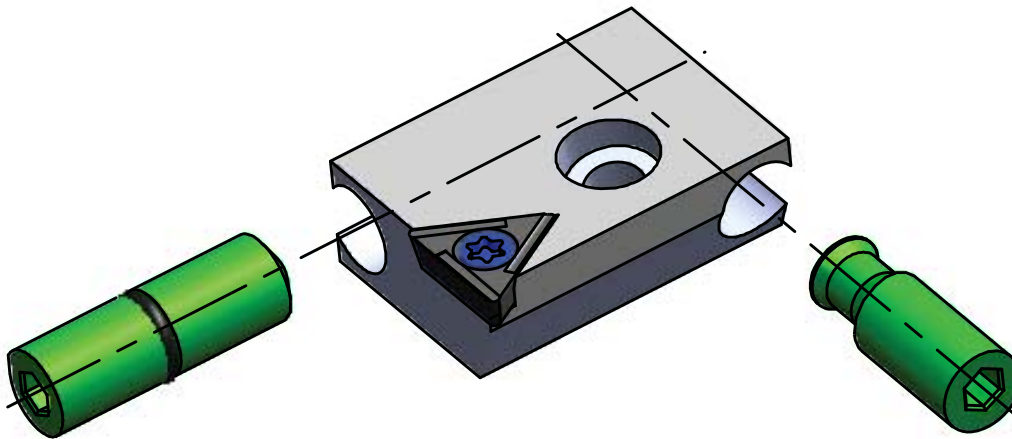

Vorteile:

- Minimale Baumaße für Werkzeuge ab D=20 mm
- Enge Bohrungstoleranzen (IT7-8)
- Einstellbereich bis 0,3 mm im Durchmesser
- Unabhängige Längen- und Durchmessereinstellung ohne Winkeländerung
- Schnell und präzise einstellbar
- Große Schnittbreite durch stabilen und kompakten Aufbau möglich
- Für viele WSP-Formen (A, C, M, S, T, X...) und Größen verwendbar
- Schutz des Werkzeuges bei Plattenbruch

Advantages:

- Compact design for tools starting from D=20 mm
- Tight bore tolerances (IT7-8)
- Diameter setting range 0.3 mm
- Independent length and diameter setting without influence on the cutting edge angle
- Quick and precise setting
- Large cutting widths possible due to the rigid design
- Usable for many insert shapes (A, C, M, S, T, X...) and sizes
- Tool protection in case of insert breakage

RPK: Kleinste verstellbare Durchmesser / RPK: Smallest cutting diameter for radial adjustment

WSP-Größe / Insert size	Z1	Z2	Z3
SC..0602..	20	26	32
SC..0903..	30	40	50
SC..1204..	40	47	60

Übrigens: Durch Kombination hochgenauer Wendeschneidplatten mit Präzisions-WSP-Sitzen können wir Sonderwerkzeuge für Passungen H8 auch ohne WSP-Verstellung realisieren. Bitte fragen Sie an!

Tip: We can offer tools for close tolerances like H8 also without insert adjustment by combination of high-precision inserts and insert seats. Please send us your request!

Preci-Cut Sonderlösung / Special solution

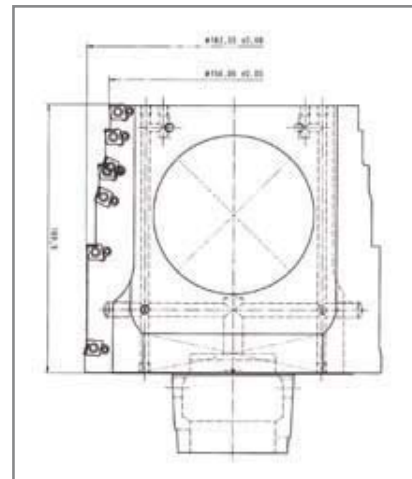

Stufen-Preci-Cut mit einstellbaren PKD-WSP / Step-Preci-Cut with adjustable PCD-inserts d=156x186



Vorteile:

- Selbstzentrierend durch Kernschneide und zwei symmetrische Wendeschneidplatten
- Hohe Zähigkeit im Zentrum beim Anbohren durch HSS-Kernschneide
- Hoher Vorschub durch 2 Schneiden
- Enge Bohrungstoleranzen (H11)
- Geradliniger Bohrungsverlauf durch Führungsfasen an den WSP
- Universell mit HM- und HSE-WSP einsetzbar
- Auch für labilen Einsatzbedingungen geeignet
- Paketbearbeitung möglich

Advantages:

- Self-centering by means of core cutter and symmetrically positioned indexable inserts
- High toughness due to HSS-core cutter in the centre
- High feed rate with two inserts
- Close drilling tolerances (H11)
- Straight bores due to guiding chamfers on the inserts
- Universally usable with carbide and HSS-inserts
- Also usable in unstable conditions
- Machining of stacked bores possible

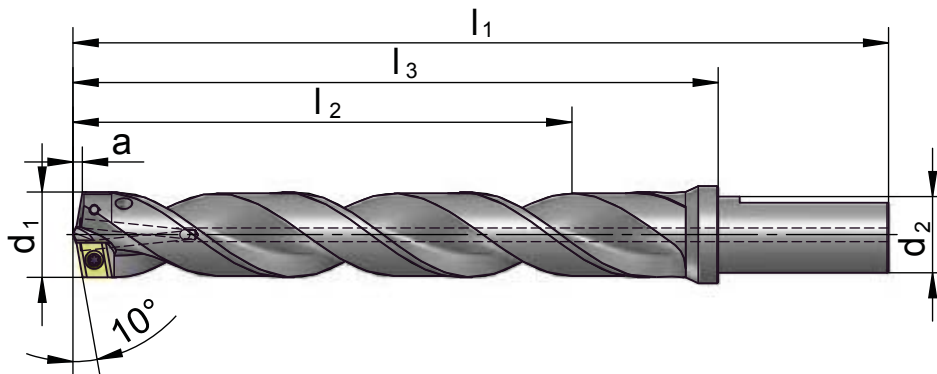
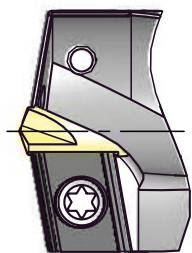

FLX02

d ₁ +/-0,05	a	l ₁	l ₂	l ₃	d ₂ BZM	Best.-Nr./ Ord.-No
						FLX02
18	2,2	200	120	150	20	FLX02 18 A
19	2,3	200	120	150	20	FLX02 19 A
20	2,4	200	120	150	20	FLX02 20 A
21	2,5	230	144	174	25	FLX02 21 A
22	2,6	230	144	174	25	FLX02 22 A
23	2,7	230	144	174	25	FLX02 23 A
24	2,8	230	144	174	25	FLX02 24 A
25	3,0	250	162	194	25	FLX02 25 A
26	3,1	250	162	194	25	FLX02 26 A
27	3,2	250	162	194	25	FLX02 27 A
28	3,3	280	186	224	25	FLX02 28 A
29	3,4	280	186	224	25	FLX02 29 A
30	3,4	280	186	224	25	FLX02 30 A
31	3,5	280	186	224	25	FLX02 31 A
32	3,8	325	222	265	32	FLX02 32 A
33	3,9	325	222	265	32	FLX02 33 A
34	4,0	325	222	265	32	FLX02 34 A
35	4,1	325	222	265	32	FLX02 35 A
36	4,2	325	222	265	32	FLX02 36 A
37	4,3	325	222	265	32	FLX02 37 A
38	4,5	340	234	280	32	FLX02 38 A
39	4,6	340	234	280	32	FLX02 39 A

Andere Abmessungen und Ausführungen auf Anfrage / Other dimensions and designs upon request

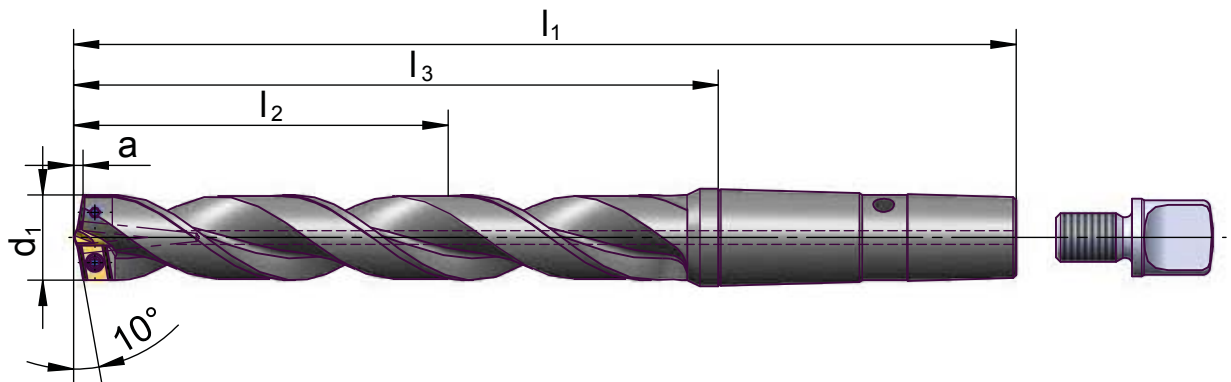

FLXM

d ₁ +/-0,05	a	l ₁	l ₂	l ₃	MK MT	Best.-Nr./ Ord.-No	
						FLXM	
18	2,2	191	110	136	2	FLXM 1800202	EAL 012
19	2,3	226	140	171	2	FLXM 1900202	EAL 012
20	2,4	226	140	171	2	FLXM 2000202	EAL 012
21	2,5	226	140	171	2	FLXM 2100202	EAL 012
22	2,6	226	140	171	2	FLXM 2200202	EAL 012
23	2,7	226	140	171	2	FLXM 2300202	EAL 012
24	2,8	272	160	201	3	FLXM 2400302	EAL 013
25	3,0	272	160	201	3	FLXM 2500302	EAL 013
26	3,1	272	160	201	3	FLXM 2600302	EAL 013
27	3,2	272	160	201	3	FLXM 2700302	EAL 013
28	3,3	302	190	231	3	FLXM 2800302	EAL 013
29	3,4	302	190	231	3	FLXM 2900302	EAL 013
30	3,4	302	190	231	3	FLXM 3000302	EAL 013
31	3,5	302	190	231	3	FLXM 3100302	EAL 013
32	3,8	348	210	258	4	FLXM 3200402	EAL 014
33	3,9	348	210	258	4	FLXM 3300402	EAL 014
34	4,0	348	210	258	4	FLXM 3400402	EAL 014
35	4,1	348	210	258	4	FLXM 3500402	EAL 014
36	4,2	383	240	293	4	FLXM 3600402	EAL 014
37	4,3	383	240	293	4	FLXM 3700402	EAL 014
38	4,5	383	240	293	4	FLXM 3800402	EAL 014
39	4,6	383	240	293	4	FLXM 3900402	EAL 014

* separat bestellen / order separately

Schneiden, Ersatzteile und Zubehör s. S. 14-15 / inserts, spare parts and accessories s. p. 14-15

Schnittdatenempfehlung / Cutting data recommendation:

		Niedrigleg. Stahl Low alloy Steel	Hochleg. Stahl High alloy steel	Gusseisen Cast iron	Aluminium
		z.B./e.g. C45E	z.B./e.g. X20Cr13	z.B./e.g. GJL, GJS	z.B./e.g. AlSi10Mg
HM / Carbide	Vc	60 - 130	50 - 120	80 - 120	100 - 500
HSSE (S6)	Vc	25 - 40	20-35		
Ø d					
18 - 21	f	0,15 - 0,25	0,10 - 0,20	0,20 - 0,30	0,20 - 0,35
22 - 28	f	0,18 - 0,30	0,15 - 0,25	0,20 - 0,40	0,20 - 0,40
> 29	f	0,20 - 0,35	0,18 - 0,30	0,25 - 0,50	0,25 - 0,50

Schnittgeschwindigkeit / Cutting speed
Vc (m/min)



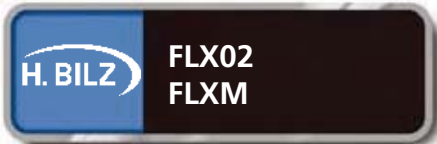

Vorschub / Infeed
f (mm/U) / (mm/rev)

Ausreichende Kühlschmierstoff-Zufuhr erforderlich / Sufficient coolant supply needed



Flexispeed FLX02/FLXM

Schneiden, Ersatzteile und Zubehör Inserts, Spare Parts and Accessories

					
mm Ø	FLX02 6 x D, zyl. / cyl.	FLXM 6 x D, MK / MT	Kernschneide HSSE* / Core Cutter HSSE (N = TiN)	Wendeschneidplatte* / Insert	
18	FLX02 18 A	FLXM 1800202	KEN01 052 (N)	XCEX 070204 FRZ ...	
19	FLX02 19 A	FLXM 1900202	KEN01 052 (N)	XCEX 075204 FRZ ...	
20	FLX02 20 A	FLXM 2000202	KEN01 052 (N)	XCEX 080204 FRZ ...	
21	FLX02 21 A	FLXM 2100202	KEN01 052 (N)	XCEX 085304 FRZ ...	
22	FLX02 22 A	FLXM 2200202	KEN01 052 (N)	XCEX 090304 FRZ ...	
23	FLX02 23 A	FLXM 2300202	KEN01 052 (N)	XCEX 095304 FRZ ...	
24	FLX02 24 A	FLXM 2400302	KEN01 052 (N)	XCEX 100304 FRZ ...	
25	FLX02 25 A	FLXM 2500302	KEN01 062 (N)	XCEX 100304 FRZ ...	
26	FLX02 26 A	FLXM 2600302	KEN01 062 (N)	XCEX 105304 FRZ ...	
27	FLX02 27 A	FLXM 2700302	KEN01 062 (N)	XCEX 110304 FRZ ...	
28	FLX02 28 A	FLXM 2800302	KEN01 062 (N)	XCEX 115304 FRZ ...	
29	FLX02 29 A	FLXM 2900302	KEN01 062 (N)	XCEX 120304 FRZ ...	
30	FLX02 30 A	FLXM 3000302	KEN01 062 (N)	XCEX 125304 FRZ ...	
31	FLX02 31 A	FLXM 3100302	KEN01 062 (N)	XCEX 130304 FRZ ...	
32	FLX02 32 A	FLXM 3200402	KEN01 082 (N)	XCEX 125304 FRZ ...	
33	FLX02 33 A	FLXM 3300402	KEN01 082 (N)	XCEX 130304 FRZ ...	
34	FLX02 34 A	FLXM 3400402	KEN01 082 (N)	XCEX 135404 FRZ ...	
35	FLX02 35 A	FLXM 3500402	KEN01 082 (N)	XCEX 140404 FRZ ...	
36	FLX02 36 A	FLXM 3600402	KEN01 082 (N)	XCEX 145404 FRZ ...	
37	FLX02 37 A	FLXM 3700402	KEN01 082 (N)	XCEX 150404 FRZ ...	
38	FLX02 38 A	FLXM 3800402	KEN01 102 (N)	XCEX 145404 FRZ ...	
39	FLX02 39 A	FLXM 3900402	KEN01 102 (N)	XCEX 150404 FRZ ...	

* Separat bestellen / Order separately



Andere Abmessungen (auch größere Durchmesser) auf Anfrage /
Other dimensions (also larger diameters) upon request

HM-Kernschneiden auf Anfrage / Carbide core cutters on request

WSP mit Spanteiler und andere Ausführungen auf Anfrage /
Inserts with chip splitter and other designs on request

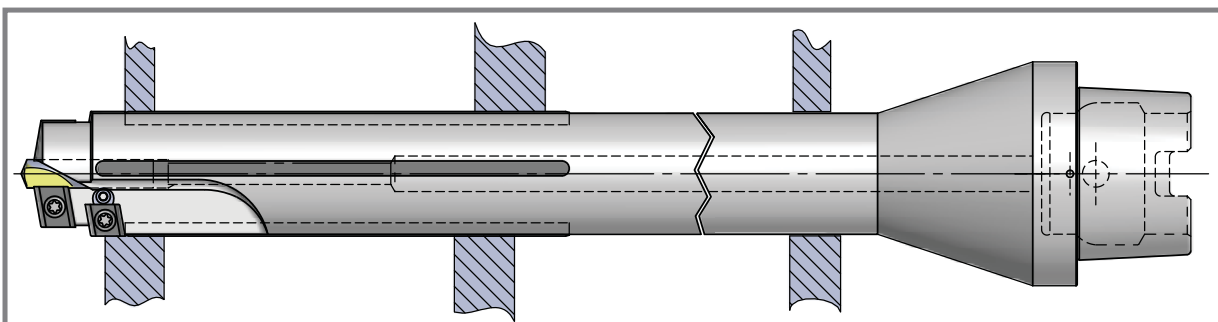
Flexispeed Sonderlösung mit Führungsleisten und einstellbaren WSP / Flexispeed in special design with guide pads and adjustable inserts



									 *
Werkstoffgruppe (s. S. 22) / Material class (s. p. 22)							Klemmschraube für Kernschneide / Fixing screw for core cutter		
N K S	K	K	P	P	P K S				
Schneidstoffsorte / Grade									
...AK1	... K1	...K9	...P2	...P7	...S6	KLS 010406	TX 25050	TX 208	
...AK1	... K1	...K9	...P2	...P7	...S6	KLS 010406	TX 25050	TX 208	
...AK1	... K1	...K9	...P2	...P7	...S6	KLS 010406	TX 25050	TX 208	
...AK1	... K1	...K9	...P2	...P7	...S6	KLS 010406	TX 35075	TX 215	
...AK1	... K1	...K9	...P2	...P7	...S6	KLS 010406	TX 35075	TX 215	
...AK1	... K1	...K9	...P2	...P7	...S6	KLS 010406	TX 35075	TX 215	
...AK1	... K1	...K9	...P2	...P7	...S6	KLS 010406	TX 35075	TX 215	
...AK1	... K1	...K9	...P2	...P7	...S6	KLS 010508	TX 35075	TX 215	
...AK1	... K1	...K9	...P2	...P7	...S6	KLS 010508	TX 35075	TX 215	
...AK1	... K1	...K9	...P2	...P7	...S6	KLS 010508	TX 35075	TX 215	
...AK1	... K1	...K9	...P2	...P7	...S6	KLS 010508	TX 35075	TX 215	
...AK1	... K1	...K9	...P2	...P7	...S6	KLS 010508	TX 35075	TX 215	
...AK1	... K1	...K9	...P2	...P7	...S6	KLS 010508	TX 35075	TX 215	
...AK1	... K1	...K9	...P2	...P7	...S6	KLS 010508	TX 35075	TX 215	
...AK1	... K1	...K9	...P2	...P7	...S6	KLS 010508	TX 35075	TX 215	
...AK1	... K1	...K9	...P2	...P7	...S6	KLS 010610	TX 35075	TX 215	
...AK1	... K1	...K9	...P2	...P7	...S6	KLS 010610	TX 35075	TX 215	
...AK1	... K1	...K9	...P2	...P7	...S6	KLS 010610	TX 45115	TX 215	
...AK1	... K1	...K9	...P2	...P7	...S6	KLS 010610	TX 45115	TX 215	
...AK1	... K1	...K9	...P2	...P7	...S6	KLS 010612	TX 45115	TX 215	
...AK1	... K1	...K9	...P2	...P7	...S6	KLS 010612	TX 45115	TX 215	
...AK1	... K1	...K9	...P2	...P7	...S6	KLS 010612	TX 45115	TX 215	
...AK1	... K1	...K9	...P2	...P7	...S6	KLS 010612	TX 45115	TX 215	
...AK1	... K1	...K9	...P2	...P7	...S6	KLS 010612	TX 45115	TX 215	

Schneidstoffsorten / Grades

Sorte Grade	DIN-ISO 513	Schneidstoff Cutting material	Werkstoffgruppe / Material class			
			Stahl Steel	Gusseisen Cast iron	Nichteisen- metalle Nonferrous metal	Speziallegier- ungen und Titan Special alloys and Titanium
			P	K	N	S
AK1	HW - N20	HM / Carbide		o	+	o
K1	HF - K20	HM / Carbide		+		
K9	HC - K10	HM- / Carbide TiAlN		+		
P2	HF - P30	HM / Carbide	+			
P7	HC - P40	HM- / Carbide TiN	+	o		
S6		HSSE-TiN	+	o		+

Bestellbeispiel / Order example:

⇓	2 Stück/pieces FLXM 2700302
⇓	6 Stück/pieces KEN01 062N
⇓	10 Stück/pieces XCEX 110304 FRZP7
⇓	2 Stück/pieces EAL 013
⇓	1 Stück/piece TX 215
⇓	10 Stück/pieces TX 35075
⇓	5 Stück/pieces KLS 010508

+ = Hauptanwendung / Main application
o = Nebenanwendung / Minor application

Bohrsystem KSB/KBH Drilling system KSB/KBH

8 x D



GJL / GJS

ALU

ST(AHL)

NE

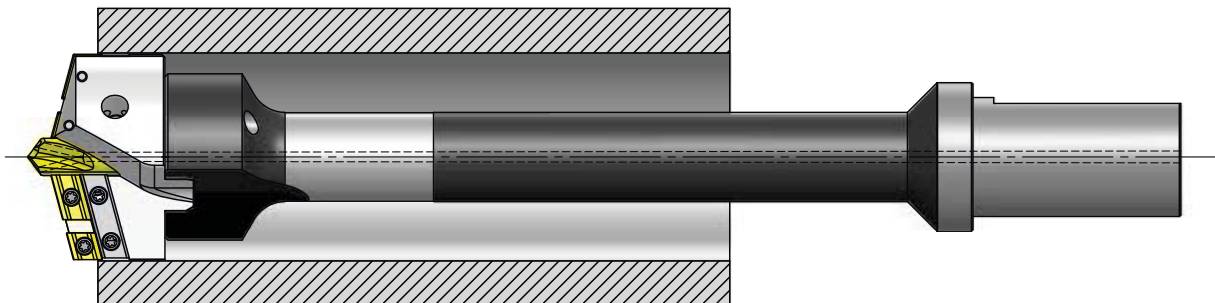

Vorteile:

- Hochpositive Schneidengeometrie für geringe Antriebsleistung
- Hoher Vorschub durch maximale Schneidenüberdeckung
- Hohe Leistungsfähigkeit und übertragbare Schnittmomente durch ungeteilte Halter
- Enge Bohrungstoleranzen (H11)
- Geradliniger Bohrungsverlauf durch Führungsfasen der äußeren WSP
- Führungsplatten für schrägen Austritt und Schnittunterbrechung (KSB03)
- Universell mit HM- und HSSE-WSP einsetzbar
- Auch für labile Einsatzbedingungen geeignet
- Paketbearbeitung möglich

Advantages:

- Very positive rake angle for low machine power requirement
- High feed rate due to maximum overlap of inserts
- High performance by rigid and undivided holder
- Close drilling tolerances (H11)
- Straight bores due to guiding chamfers on the external inserts
- Guide plates for inclined bore outlets and cut interruptions (KSB03)
- Universally usable with carbide and HSS-inserts
- Also usable in unstable conditions
- Machining of staked bores possible

Schneidkopf KSB03 / Cutter head KSB03

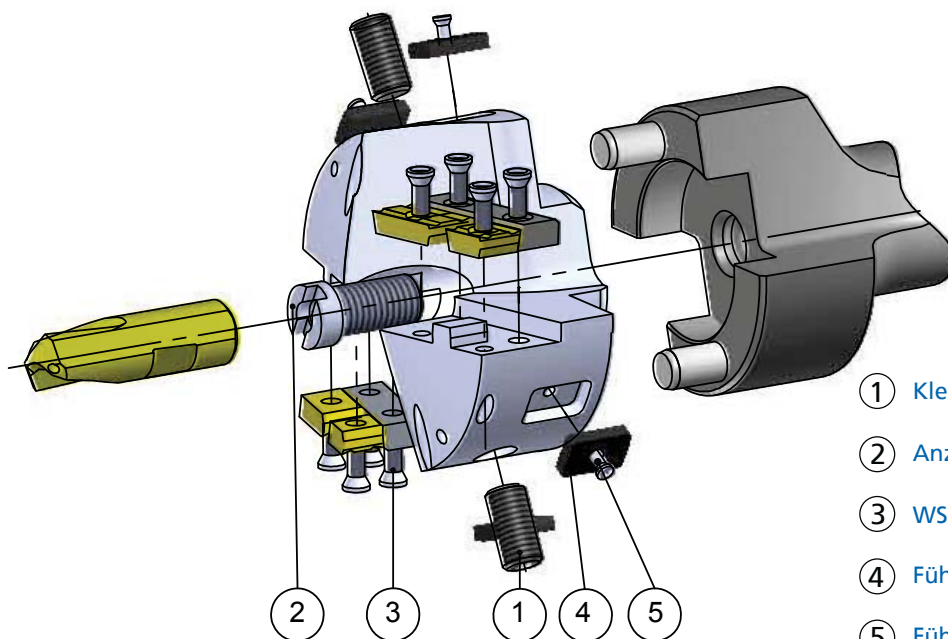

- ① Klemmschraube / Fixing screw
- ② Anzugsschraube / Cutter head screw
- ③ WSP-Schraube / Insert screw
- ④ Führungsplatte / Guide plate
- ⑤ Führungsplatten-Schraube / Guide plate screw

Powerbore-Schneidköpfe / Cutter heads

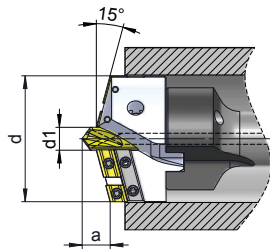

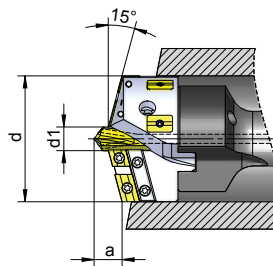

KSB01 ohne HM-Führungsplatten / without carbide guide plates



KSB03 mit HM-Führungsplatten / with carbide guide plates

Ersatzteile für KSB03 / Spare parts for KSB03

d	d ₁	a*	Anzahl WSP / No. of inserts	Größe / Size BZS	Best.-Nr. / Ord.-No
					KSB01
39	11	10	3	08	KSB01 039
40	11	10	3	08	KSB01 040
45	11	10	3	08	KSB01 045
48	11	11	4	08	KSB01 048
50	11	11	4	09	KSB01 050
57	11	12	4	09	KSB01 057
60	13	14	4	1	KSB01 060
67	13	15	4	1	KSB01 067
70	13	16	4	1	KSB01 070
77	13	17	4	1	KSB01 077
80	13	17	5	2	KSB01 080
87	13	18	5	2	KSB01 087
90	13	18	5	2	KSB01 090
97	13	19	6	2	KSB01 097
100	13	20	6	3	KSB01 107
107	13	21	6	3	KSB01 107
110	13	21	6	3	KSB01 110
117	13	22	6	3	KSB01 117
120	16	23	6	4	KSB01 120
127	16	24	8	4	KSB01 127
130	16	24	8	4	KSB01 130
137	16	25	8	4	KSB01 137
140	16	26	8	4	KSB01 140
147	16	27	10	4	KSB01 147
150	16	27	10	4	KSB01 150
157	16	28	10	4	KSB01 157
160	16	28	10	4	KSB01 160

Best.-Nr. / Ord.-No	Stk. / Pcs.	 ④	 ⑤
		Führungsplatten / guide plates	
KSB03 039	4	Z7S 0400	TX 25050S
KSB03 040	4	Z7S 0400	TX 25050S
KSB03 045	4	Z7S 0400	TX 25050S
KSB03 048	4	Z7S 0400	TX 25050S
KSB03 050	4	Z7S 0500	TX 25050S
KSB03 057	4	Z7S 0500	TX 25050S
KSB03 060	4	Z7S 0600	TX 35095S
KSB03 067	4	Z7S 0600	TX 35095S
KSB03 070	4	Z7S 0700	TX 35095S
KSB03 077	4	Z7S 0700	TX 35095S
KSB03 080	6	Z7S 0800	TX 35095S
KSB03 087	6	Z7S 0800	TX 35095S
KSB03 090	6	Z7S 0800	TX 35095S
KSB03 097	6	Z7S 0900	TX 35095S
KSB03 107	6	Z7S 0900	TX 35095S
KSB03 107	6	Z7S 0900	TX 35095S
KSB03 110	6	Z7S 1200	TX 35095S
KSB03 117	6	Z7S 1200	TX 35095S
KSB03 120	6	Z7S 1200	TX 35095S
KSB03 127	6	Z7S 1200	TX 35095S
KSB03 130	6	Z7S 1200	TX 35095S
KSB03 137	6	Z7S 1400	TX 35095S
KSB03 140	6	Z7S 1400	TX 35095S
KSB03 147	6	Z7S 1400	TX 35095S
KSB03 150	6	Z7S 1400	TX 35095S
KSB03 157	6	Z7S 1400	TX 35095S
KSB03 160	6	Z7S 1400	TX 35095S

* Bei Verwendung von ZB02... / When using ZB02...

Zwischenabmessungen kurzfristig lieferbar / Intermediate dimensions available on short term

Andere Abmessungen und Ausführungen auf Anfrage / Other dimensions and designs upon request

Schneiden, Halter, Ersatzteile und Zubehör s. S. 18-19 / Inserts, holder and spare parts s. p. 18-19

Schnittdatenempfehlung / Cutting data recommendation:

Ø d	V _c	Niedrigleg. Stahl Low alloy Steel		Hochleg. Stahl High alloy steel		Gusseisen Cast iron	Aluminium
		z.B./e.g. C45E		z.B./e.g. 42CrMo4		z.B./e.g. GJL, GJS	z.B./e.g. AlSi10Mg
		HM (P)	HSSE (S6)	HM (P)	HSSE (S6)	HM (P)	HM (P)
39 - 58	f	0,20 - 0,25	0,20 - 0,30	0,20 - 0,25	0,20 - 0,30	0,20 - 0,35	0,20 - 0,35
59 - 99	f	0,20 - 0,30	0,25 - 0,40	0,20 - 0,30	0,25 - 0,40	0,25 - 0,40	0,20 - 0,40
>= 100	f	0,25 - 0,35	0,30 - 0,60	0,25 - 0,35	0,30 - 0,50	0,30 - 0,50	0,25 - 0,50

Schnittgeschwindigkeit / Cutting speed





V_c (m/min)

Vorschub / Infeed

f (mm/U) / (mm/rev)

Ausreichende Kühlschmierstoff-Zufuhr erforderlich / Sufficient coolant supply needed

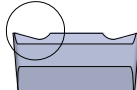
Schneiden, Halter und Ersatzteile Inserts, holders and spare parts

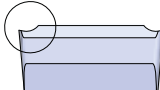
		Wendeschneidplatten / Inserts						
								
Schneidkopf / Cutter Head	Zentrums- bohrer / Centre Drill	Stk. / Pcs	Hochpositive Spanleit- stufen / Very positive rake angle	Sorte (s. S. 22) / Grade (s. p. 22)			Spanleitstufen für kurze Späne auch bei geringem Vorschub / Chip breakers for short chips already at low feed rates	
KSB Ø (s. S.17 / s.p.17)								
38,0 - 42,9	ZB021135N	2	XBHX 060304 FR3...	P7	P9	S6	XBHX 060304 FR7 P9	
		1	XBHX 110304 FR3...	P7	P9	S6	XBHX 110304 FR7 P9	
43,0 - 45,9	ZB021135N	1	XBHX 060304 FR3...	P7	P9	S6	XBHX 060304 FR7 P9	
		1	XBHX 080304 FR3...	P7	P9	S6	XBHX 080304 FR7 P9	
		1	XBHX 110304 FR3...	P7	P9	S6	XBHX 110304 FR7 P9	
46,0 - 47,4	ZB021135N	2	XBHX 080304 FR3...	P7	P9	S6	XBHX 080304 FR7 P9	
		1	XBHX 110304 FR3...	P7	P9	S6	XBHX 110304 FR7 P9	
47,5 - 48,9	ZB021135N	1	XBHX 060304 FR3...	P7	P9	S6	XBHX 060304 FR7 P9	
		2	XBHX 080304 FR3...	P7	P9	S6	XBHX 080304 FR7 P9	
		1	XBHX 110304 FR3...	P7	P9	S6	XBHX 110304 FR7 P9	
49,0 - 52,9	ZB021135N	1	XBHX 060304 FR3...	P7	P9	S6	XBHX 060304 FR7 P9	
		2	XBHX 080304 FR3...	P7	P9	S6	XBHX 080304 FR7 P9	
		1	XBHX 110304 FR3...	P7	P9	S6	XBHX 110304 FR7 P9	
53,0 - 57,9	ZB021135N	3	XBHX 080304 FR3...	P7	P9	S6	XBHX 080304 FR7 P9	
		1	XBHX 110304 FR3...	P7	P9	S6	XBHX 110304 FR7 P9	
58,0 - 59,9*	ZB021346N	1	XBHX 090404 FR3...	P7	P9	S6	XBHX 090404 FR7 P9	
		1	XBHX 100404 FR3...	P7	P9	S6	XBHX 100404 FR7 P9	
		1	XBHX 150404 FR3...	P7	P9	S6	XBHX 150404 FR7 P9	
60,0 - 65,9	ZB021346N	2	XBHX 090404 FR3...	P7	P9	S6	XBHX 090404 FR7 P9	
		2	XBHX 120404 FR3...	P7	P9	S6	XBHX 120404 FR7 P9	
66,0 - 69,5	ZB021346N	2	XBHX 090404 FR3...	P7	P9	S6	XBHX 090404 FR7 P9	
		2	XBHX 150404 FR3...	P7	P9	S6	XBHX 150404 FR7 P9	
69,6 - 79,9	ZB021346N	2	XBHX 100404 FR3...	P7	P9	S6	XBHX 100404 FR7 P9	
		2	XBHX 150404 FR3...	P7	P9	S6	XBHX 150404 FR7 P9	
80,0 - 85,5	ZB021356N	3	XBHX 090404 FR3...	P7	P9	S6	XBHX 090404 FR7 P9	
		2	XBHX 150404 FR3...	P7	P9	S6	XBHX 150404 FR7 P9	
85,6 - 90,5	ZB021356N	3	XBHX 100404 FR3...	P7	P9	S6	XBHX 100404 FR7 P9	
		2	XBHX 150404 FR3...	P7	P9	S6	XBHX 150404 FR7 P9	
90,6 - 92,5	ZB021356N	2	XBHX 100404 FR3...	P7	P9	S6	XBHX 100404 FR7 P9	
		1	XBHX 120404 FR3...	P7	P9	S6	XBHX 120404 FR7 P9	
		2	XBHX 150404 FR3...	P7	P9	S6	XBHX 150404 FR7 P9	
92,6 - 96,5	ZB021356N	4	XBHX 090404 FR3...	P7	P9	S6	XBHX 090404 FR7 P9	
		2	XBHX 150404 FR3...	P7	P9	S6	XBHX 150404 FR7 P9	
96,6 - 99,9	ZB021356N	4	XBHX 100404 FR3...	P7	P9	S6	XBHX 100404 FR7 P9	
		2	XBHX 150404 FR3...	P7	P9	S6	XBHX 150404 FR7 P9	
100,0 - 106,5	ZB021356N	4	XBHX 100404 FR3...	P7	P9	S6	XBHX 100404 FR7 P9	
		2	XBHX 150404 FR3...	P7	P9	S6	XBHX 150404 FR7 P9	
106,6 - 119,9	ZB021356N	2	XBHX 090404 FR3...	P7	P9	S6	XBHX 090404 FR7 P9	
		4	XBHX 150404 FR3...	P7	P9	S6	XBHX 150404 FR7 P9	
120,0 - 126,5	ZB021657N	2	XBHX 090404 FR3...	P7	P9	S6	XBHX 090404 FR7 P9	
		4	XBHX 150404 FR3...	P7	P9	S6	XBHX 150404 FR7 P9	
126,6 - 129,5	ZB021657N	6	XBHX 090404 FR3...	P7	P9	S6	XBHX 090404 FR7 P9	
		2	XBHX 150404 FR3...	P7	P9	S6	XBHX 150404 FR7 P9	
129,6 - 145,5	ZB021657N	6	XBHX 100404 FR3...	P7	P9	S6	XBHX 100404 FR7 P9	
		2	XBHX 150404 FR3...	P7	P9	S6	XBHX 150404 FR7 P9	
145,6 - 152,9	ZB021657N	8	XBHX 090404 FR3...	P7	P9	S6	XBHX 090404 FR7 P9	
		2	XBHX 150404 FR3...	P7	P9	S6	XBHX 150404 FR7 P9	
153,0 - 160	ZB021657N	8	XBHX 100404 FR3...	P7	P9	S6	XBHX 100404 FR7 P9	
		2	XBHX 150404 FR3...	P7	P9	S6	XBHX 150404 FR7 P9	

Andere Abmessungen und Ausführungen auf Anfrage /
Other dimensions and designs upon request

* Für Bohrdurchmesser 58-59,9 muss der Halterdurchmesser reduziert werden.
Bei Bestellung bitte angeben! / Diameter of holders must be reduced for
cutter head from diameter 58 to 59.9. Please indicate when ordering!

Halter / Holder											
			(incl.)								
MK DIN 228				SK 50 DIN69871 AD+B				ABS (Lizenz Komet)		Zylinder-Schaft / Cylinder shank D=40	
Größe/ Size	BT	Best.-Nr./ Ord.-No	MK		BT	Best.-Nr./ Ord.-No	BT	Best.-Nr./ Ord.-No	ABS	BT	Best.-Nr./ Ord.-No
Size			MT								
08	105	KBH0 0804 A	4	EAL014			105	KBH2 0850 A	50	105	KBH4 0840 A
	205	KBH0 0804 B			205	KBH2 0850 B	205	KBH4 0840 B			
	300	KBH0 0804 C			300	KBH4 0840 C					
09	130	KBH0 0904 A	4	EAL014			130	KBH2 0963 A	63	130	KBH4 0940 A
	250	KBH0 0904 B			250	KBH2 0963 B	250	KBH4 0940 B			
	390	KBH0 0904 C			390	KBH4 0940 C					
1	120	KBH0 104 A	4	EAL014			120	KBH2 163 A	63	120	KBH4 1040 A
	245	KBH0 104 B			245	KBH1 150 B	245	KBH4 1040 B			
	365	KBH0 104 C			365	KBH1 150 C	365	KBH4 1040 C			
	480	KBH0 104 D			480	KBH1 150 D	480	KBH4 1040 D			
2	185	KBH0 205 A	5	EAL015							
	335	KBH0 205 B			335	KBH1 250 B					
	475	KBH0 205 C			475	KBH1 250 C					
	640	KBH0 205 D			640	KBH1 250 D					
3	185	KBH0 305 A	5	EAL015			210	KBH1 350 A			
	335	KBH0 305 B			365	KBH1 350 B					
	485	KBH0 305 C			510	KBH1 350 C					
	700	KBH0 305 D			700	KBH1 350 D					
4	185	KBH0 405 A	5	EAL015							
	335	KBH0 405 B			365	KBH1 450 B					
	485	KBH0 405 C			510	KBH1 450 C					
	700	KBH0 405 D			700	KBH1 450 D					

Bestellbeispiel / Order example:

- ➔ 1 Stück/piece Schneidkopf/Drilling head KSB01 050
KSB01 Ø 50 (s. S./s. p. 15)
- ➔ 5 Stück/pieces Zentrumsbohrer/Centre Drill ZBO 021135N
- ➔ WSP/Indexable Inserts:
20 Stück/pieces XBHX080304FR3P7
20 Stück/pieces XBHX110304FR3P7
20 Stück/pieces XBHX060304FR3P7
- ➔ 2 Stück/pieces Halter für/Holder for BT 130 KBH2 0963 A

Ersatzteile, Zubehör / Spare parts				
	①		②	
Für Schneidkopf/ For cutter head KSB Ø		Klemmschraube für Zentr. Bohrer / Fixing screw	Anzugsschraube für Schneidkopf / Cutter head screw	Mittens- schraube / Centre screw
38,0 - 57,9		KLS01 0612	ANS01 0820	TX 25050
58,0 - 119,0		KLS01 0816	ANS01 1025	TX 35095
120,0 - 160,0		KLS01 0816	ANS01 1225	TX 35095
				Schraub- dreher / Screwdriver
				TX 208
				TX 215
				TX 215

Kühlmittelzufuhr durch Schaft oder Ring / Coolant supply through shank or ring

Wendeschneidplatten / Indexable inserts

	Bezeichnung / Designation	Schneidstoffsorte (s. S. 22) / Grade (s. p. 22)									Merkmale/Anwendungsbereich / Specifications/Application area										
		Werkstoffgruppe (s. S. 22) / Material class (s.p. 22)																			
		N	K	S	P	K	M	K	H	P			P	M	P	M	H	P	M	K	S
	ACEX 170404 FRH...																			Aufbohren und Senken bis 17, 19 oder 25 mm Schnittbreite / Boring and spotfacing up to 17, 19 resp. 25 mm cutting width	TX 45115
	ACEX 190404 FRH...																				TX 45115
	ACEX 250604 FRH...																				TX 45135
	CCMT 060204...																			Bohren, Aufbohren, Fräsen mit 4 gesinterten Spanleitstufen / Drilling, boring and milling with 4 sintered chip breakers	TX 25050
	CCMT 090304...																				TX 35075
	CPGT 04T104 3...																				100264
	CPHX 09T304 L...																			Aufbohren und Senken in Alulegerungen / Boring and spotfacing in aluminium alloys	100202
	EW 4 ...																			Hinterschliffene Schneide für 90°-Kegelsenker EW / Relieve-ground cutting edge for 90°-countersink EW	
	EW 5 ...																				
	EW 6 ...																				
	LCHX 070204 FRH...																			Plansenken bis 7, 19, 25 oder 30 mm Schnittbreite / Spotfacing up to 7, 19, 25 resp. 30 mm cutting width	TX 25050
	LCEX 190404 FRH...																				TX 45115
	LCEX 250604 FRH...																				TX 45135
	LCEX 300604 FRH...																				TX 45135
	LCHX 070204 FRZ...																			Aufbohren und Senken mit Führungsfasen* bis 7, 19 oder 25 mm Schnittbreite / Boring and spotfacing with guiding chamfers* up to 7, 19 resp. 25 mm cutting width	TX 25050
	LCEX 190404 FRZ...																				TX 45115
	LCEX 250604 FRZ...																				TX 45135
	MCEX 060204 FRH...																			2 geschliffene Spanleitstufen für Rückwärtsbohrstange RBS+ / 2 ground chip breakers for Reverse boring bar RBS+	TX 25050
	MCEX 090304 FRH...																				TX 35075
	MCEX 120404 FRH...																				TX 45115
	MCEX 160604 FRH...																				TX 45135
	MCMT 060204 EN...																			4 gesinterte Spanleitstufen für Rückwärtsbohrstange RBS+ / 4 sintered chip breakers for Reverse boring bar RBS+	TX 25050
	MCMT 090304 EN...																				TX 35075
	MCMT 120404 EN...																				TX 45115
	MCMT 160604 EN...																				TX 45135
	SCHW 060204 FN...																			Plansenken und Fräsen ohne Spanleitstufen / Spotfacing and milling without chip breakers	TX 25050
	SCHW 090304 FN...																				TX 35075
	SCHW 0903AC FRH...																			Aufbohren mit geringen Zerspanungsquerschnitten / Boring with small cutting width	TX 35075
	SCHW 0602AC FRZ...																			Aufbohren mit geringen Zerspanungsquerschnitten und Führungsfasen* / Boring with small cutting width and guiding chamfers*	TX 25050
	SCHW 0903AC FRZ...																				TX 35075
	SCHW 1204AC FRZ...																				TX 45115
	SCHX 060202 FN1...																			Plansenken und Fräsen mit 4 geschliffenen Spanleitstufen / Spotfacing and milling with 4 ground chip breakers	TX 25050
	SCHX 090304 FN1...																				TX 35075
	SCHX 060204 FRH...																			Aufbohren und Senken mit 2 geschliffenen Spanleitstufen / Boring and spotfacing with 2 ground chip breakers	TX 25050
	SCHX 090304 FRH...																				TX 35075
	SCHX 120404 FRH...																				TX 45115
	SCHX 150604 FRH...																				TX 45135
	SCHX 060202 FRZ...																			Aufbohren und Senken mit Führungsfasen* und 2 geschliffenen Spanleitstufen / Boring and spotfacing with guiding chamfers* and 2 ground chip breakers	TX 25050
	SCHX 060204 FRZ...																				TX 25050
	SCHX 090304 FRZ...																				TX 35075
	SCHX 090308 FRZ...																				TX 35075
	SCHX 090310 FRZ...																				TX 35075
	SCHX 090312 FRZ...																				TX 35075
	SCHX 120404 FRZ...																				TX 45115
	SCHX 150604 FRZ...																				TX 45135
	SCHX 090304 FRZ4...																			Aufbohren mit 4 Führungsfasen* und geschliffenen Spanleitstufen (nur in speziellen WSP-Sitzen verwendbar) / Boring with 4 guiding chamfers* and ground chip breakers (usable only in special insert pockets)	TX 35075
	SCHX 120404 FRZ4...																			TX 45115	
	SCHX 060204 FRZ7...																			Aufbohren und Senken mit Führungsfasen* und Spanleitstufen für kurze Späne** / Boring and spotfacing with guiding chamfers* and chip breakers for short chips**	TX 25050
	SCHX 090304 FRZ7...																				TX 35075
	SCHX 120404 FRZ7...																				TX 45115
	SCMT 060204 EN...																			Plansenken und Fräsen mit 4 gesinterten Spanleitstufen / Spotfacing and milling with 4 sintered chip breakers	TX 25050
	SCMT 090304 EN...																				TX 35075
	SCMT 120404 EN...																				TX 45115
	SCMT 150604 EN...																				TX 45135

*/** Beschreibung s. S. 22 / Description s. p. 22

Schrauben ausreichend an Gewinde und Oberfläche schmieren /
Screws must be greased sufficiently on surface and thread

	Bezeichnung / Designation	Schneidstoffsorte (s. S. 22) / Grade (s. p. 22)									Merkmale/Anwendungsbereich / Specifications/Application area														
		AK1	K1	K9	P2	P7	P9	S6	U9																
		Werkstoffgruppe (s. S. 22) / Material class (s.p. 22)																							
		N	K	S	K	M	K	H	P	P	M	P	M	H	P	M	K	S	P	M	K	H			
	SCMX 060204 ER...																							Aufbohren und Senken mit 4 gesinterten Spanleitstufen bis 8 mm Schnittbreite / Boring and spot facing with 4 sintered chip breakers	TX 25050
	SCMX 090304 ER...																								TX 35075
	SCMX 120404 ER...																								TX 45115
	TCEX 090204 FL...																							Anfasen mit geschliffenen Spanleitstufen / Chamfering with ground chip breakers	TX 25050
	TCEX 060104 FL...																								TX 25050
	TCEX 060104 FR...																							Anfasen mit geschliffenen Spanleitstufen / Chamfering with ground chip breakers	TX 20048
	TCEX 090204 FR...																								TX 25050
	TCEX 16T304 FR...																								TX 35075
	TCMT 090204 EN...																							Anfasen und Senken mit gesinterten Spanleitstufen / Chamfering and countersinking with sintered chip breakers	TX 22060
	TCMT 110204 EN...																								TX 25050
	XBHX 060304 FR3...																							Hochpositive Spanleitstufen für Powerbore / High positive chip breaker for Powerbore	TX 25050
	XBHX 080304 FR3...																								TX 25050
	XBHX 090404 FR3...																								TX 35095
	XBHX 100404 FR3...																								TX 35095
	XBHX 110304 FR3...																								TX 25050
	XBHX 120404 FR3...																								TX 35095
	XBHX 150404 FR3...																								TX 35095
	XBHX 060304 FR7...																								TX 25050
	XBHX 080304 FR7...																							Spanleitstufen für kurze Späne** auch bei geringem Vorschub für Powerbore / Chip breakers for short chips** also at low feed rates	TX 25050
	XBHX 090404 FR7...																								TX 35095
	XBHX 100404 FR7...																								TX 35095
	XBHX 110304 FR7...																								TX 25050
	XBHX 120404 FR7...																								TX 35095
	XBHX 150404 FR7...																								TX 35095
	XBHX 060304 FRZ...																								TX 25050
	XCEX 065204 FRZ...																							Geschliffene Spanleitstufen und Führungsfasen* für Flexispeed / Ground chip breakers and guiding chamfers* for Flexispeed	TX 25050
	XCEX 070204 FRZ...																								TX 25050
	XCEX 075204 FRZ...																								TX 25050
	XCEX 080204 FRZ...																								TX 25050
	XCEX 085304 FRZ...																								TX 35075
	XCEX 090304 FRZ...																								TX 35075
	XCEX 095304 FRZ...																								TX 35075
	XCEX 100304 FRZ...																								TX 35075
	XCEX 105304 FRZ...																								TX 35075
	XCEX 110304 FRZ...																								TX 35075
	XCEX 115304 FRZ...																								TX 35075
	XCEX 120304 FRZ...																								TX 35075
	XCEX 125304 FRZ...																								TX 35075
	XCEX 130304 FRZ...																								TX 35075
	XCEX 135404 FRZ...																								TX 45115
	XCEX 140404 FRZ...																								TX 45115
	XCEX 145404 FRZ...																								TX 45115
	XCEX 150404 FRZ...																								TX 45115
	XCEX 170404 FRZ...																								TX 45115
	XCEX 200404 FRZ...																								TX 45115
XCEX 260604 FRZ...																							TX 45135		
	XCEX FRZ4....																						Mit Spanteilern (auf Anfrage) / With chip-splitter on request		
	XDCW 090200																						45°-Fasen für Combi-Drill SECF / 45°-chamfers for Combi-Drill SECF	TX 25050	

Andere Beschichtungen und Ausführungen auf Anfrage / Other coating and designs upon request

Sonderformen auf Anfrage lieferbar / Special insert designs available upon request

Bestellbeispiel / Order example:

➔ 10 Stück / pieces SCHX090304FRZAK1

Sonderformen* / Special insert designs



*Auf Anfrage lieferbar / Available upon request



Schneidplatten und Schneidstoffsorten
Inserts and Grades

PKD-Schneidplatten /
PCD Inserts

Anzugsmoment /
Clamping torque

Bezeichnung / Designation		Merkmale/Anwendungsbereich / Specifications/ Application area	
	SCHW 060202 FRH D1	Aufbohren von Nicht-eisenmetallen bis 2,5 bzw. 3,5 mm Schnittbreite / Boring of nonferrous metal up to 2.5 resp. 3.5 mm cutting width	TX 25050
	SCHW 090302 FRH D1		TX 35075
	SCHW 090304 FRH D1		TX 35075
	SCHW 060202 FR5 D1	Aufbohren und Plansenken von Nichteisenmetallen / Boring of nonferrous metal	TX 25050
	SCHW 090302 FR5 D1		TX 35075
	SCHW 120402 FR5 D1		TX 45115

	Nm	
TX 20048	0,6	TX 206
TX 25050	1,3	TX 108-25
TX 35075	3,5	TX 115-35
TX 35095	3,5	TX 115-35
TX 45115	5,0	TX 115-45
TX 45135	5,0	TX 115-45
100264	0,4	TX 206
100202	5,0	TX 115-45

Schneidstoffsorten und Anwendungsbereiche /
Grades and application areas

Sorte Grade	DIN-ISO 513	Schneidstoff Cutting material	Werkstoffgruppe / Material class					
			Stahl Steel	Nicht rostender Stahl Stainless steel	Gusseisen Cast iron	Nichteisenmetalle Nonferrous metal	Speziallegierungen und Titan Special alloys and Titanium	Harte Werkstoffe Hard materials
			P	M	K	N	S	H
AK1	HF - N20	HF / Carbide			o	+	o	
C1	HT - P10	Cermet	+			o		
D1	DP - N20	PKD / PCD				+		
K1	HF - K20	HF / Carbide			+			
K9	HC - K10	HM- / Carbide TiAlN		o	+			o
P2	HF - P30	HF / Carbide	+					
P5	HC - K40 / P40	HM- / Carbide TiN	+	+	o			
P7	HC - P40	HM- / Carbide TiN	+	+	o			
P9	HC - P10	HM- / Carbide TiAlN	+	+	o			o
S6		HSSE-TiN	+	+	o		+	
U9	HC - P15	HM- / Carbide Al2O3+TiN	+	o	+			o

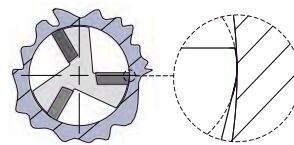

Rund geschliffene Führungsfasen der WSP (...Z...) verhindern Rattern und glätten die Bohrungsfläche -> gut geeignet für schlanke Werkzeuge mit mindestens 3 Schneiden / Round ground guiding chamfers on the insert (...Z...) prevent chattering and burnish the bore surface -> well suitable for lean tools with min. 3 cutting edges

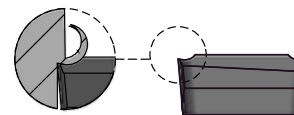

Tiefe Schneidkanten und kurze Spanleitstufen (...7...) erzeugen kurze Späne schon bei geringen Spanungsdicken -> gut geeignet für lang spanende Werkstoffe / Low cutting edge and short chip breakers (...7...) generate short chips already at low feed rates -> well suitable for long chipping materials

+ = Hauptanwendung / Main application
o = Nebenanwendung / Minor application

Formelsammlung, Leistungsberechnung
Formulas, Power calculation

	Bohren / Drilling	Aufbohren / Boring
Drehmoment / Torque (Nm)	$M_d \sim \frac{D^2 \cdot f \cdot k_c}{8000}$	$M_d \sim \frac{D (D-d) \cdot f \cdot k_c}{8000}$
Antriebsleistung / Machine power (kW)	$P_a \sim \frac{M_d \cdot n}{7643}$	$P_a \sim \frac{M_d \cdot n}{7643}$
Vorschubkraft / Thrust (N)	$F_f \sim 0,3 \cdot D \cdot f \cdot k_c$	$F_f \sim 0,3 \cdot (D-d) \cdot f \cdot k_c$

Formeln und Formelzeichen /
Formulas and symbols

Schnittgeschwindigkeit / Cutting speed

$$v_c \sim \frac{D \cdot n}{318} \quad (\text{m/min})$$

Drehzahl / Rotational speed

$$n \sim \frac{318 \cdot v_c}{D} \quad \begin{matrix} (\text{U/min}) \\ (\text{RPM}) \end{matrix}$$

Vorschubgeschwindigkeit / Feed speed

$$v_f = f \cdot n \quad (\text{mm/min})$$

Vorschub / Feed rate

$$f = \frac{v_f}{n} \quad \begin{matrix} (\text{mm/U}) \\ (\text{mm/rev}) \end{matrix}$$

Außendurchmesser / Max. cutting diameter

$$D \quad (\text{mm})$$

Innendurchmesser / Min. cutting diameter

$$d \quad (\text{mm})$$

Spezifische Schnittkraft / Specific cutting force	k_c (N/mm ²)
Stahl / Steel C45E	2000
Rostfreier Stahl / Stainless steel X20Cr13	2500
Gusseisen / Cast iron GJL/GJS	1100
Aluminium AlSi10Mg	800

Die teilweise stark vereinfachten Daten und Formeln dienen nur der überschlägigen Leistungsberechnung / The data and formulas are partly simplified and usable for an approximate calculation only



Zur Ausarbeitung eines Angebotes benötigen wir folgende Angaben / To determine tool requirements for quotations and orders:

Firma /Customer

Name /Abt./Department

.....
.....
.....

.....
Tel. Fax
Email

Werkstück /Workpiece Zeichnung beilegen / Attach drawing

Benennung /Description
Bohr-Ø/Bore-Ø / ±
Bohrtiefe/Bore depth
Vorbearbeitungs-Ø/Pre-machined-Ø

Unterbrochener Schnitt/Intermittent cut
Störkanten/Ausraglänge/Interference.....
Bohrungen/Jahr/Bores/Year.....

Werkstückstoff /Workpiece material

Bezeichnung /Description / HRC

Späne/Chips: Kurz/Short Lang/Long

Kühlmittel /Coolant

Innenkühlung/Internal coolant
 Trocken/Dry MMS/Spray mist cool.

Emulsion/Emulsion Öl/Oil
..... bar /min

Maschine /Machine

Typ/Type / kW
 Horizontal/Horizontal Vertikal/Vertical
Werkzeug/Tool: Rotierend/Rotating Stehend/Fix

n (U/min)/(rev/min).....
f (mm/U/rev)
Spindelaufnahme/Spindle type.....

Werkzeug /Tool

Benennung /Description
Ausführung/Options:
 HSS VHM/Carbide WSP/Index. inserts
 PKD/PCD/CBN HM gelötet/Brazed carbide

Beschichtung/Coating: TiAlN TiN
Schaft/Shank
Stückzahl/Quantity
Bisher verwendete Werkzeuge/Tools used so far
.....

Skizze/Sketch



Hermann Bilz GmbH & Co KG
Präzisionswerkzeuge
Röntgenstraße 30
D-73730 Esslingen

Tel. +49 (0) 7 11/9 30 25 - 0
Fax +49 (0) 7 11/9 30 25 - 20
info@hermann-bilz.de
www.hermann-bilz.de

